



Streptococcus pneumoniae



Clostridium tetani

Treponema pallidum

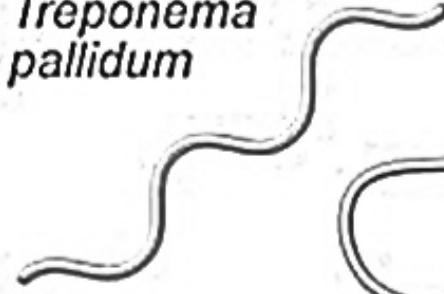

Vibrio cholerae

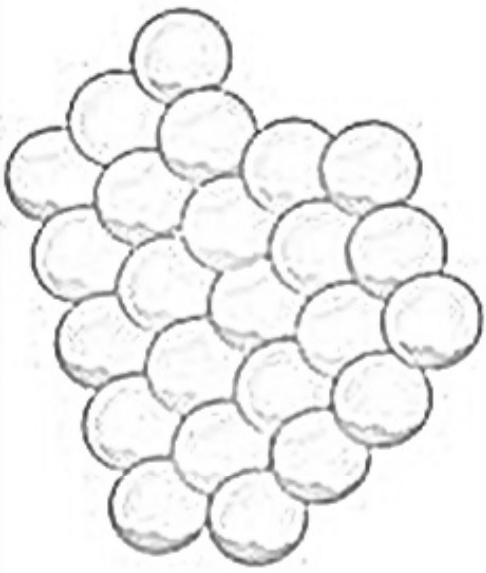

Staphylococcus aureus

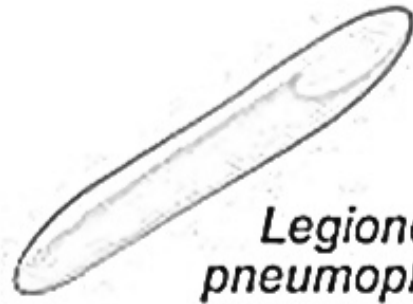

Legionella pneumophila



Salmonella typhi



Clostridium botulinum

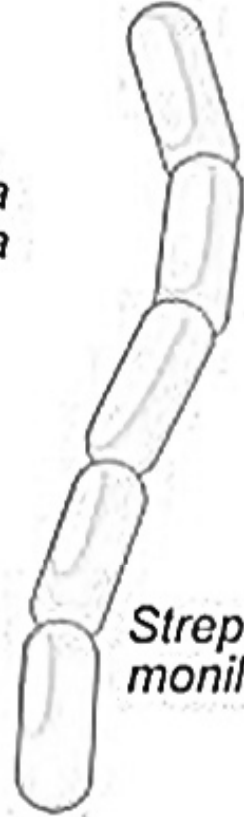

Streptobacillus moniliformis

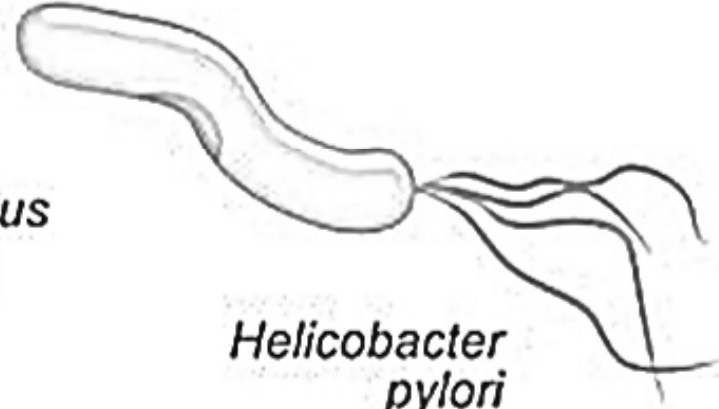

Helicobacter pylori

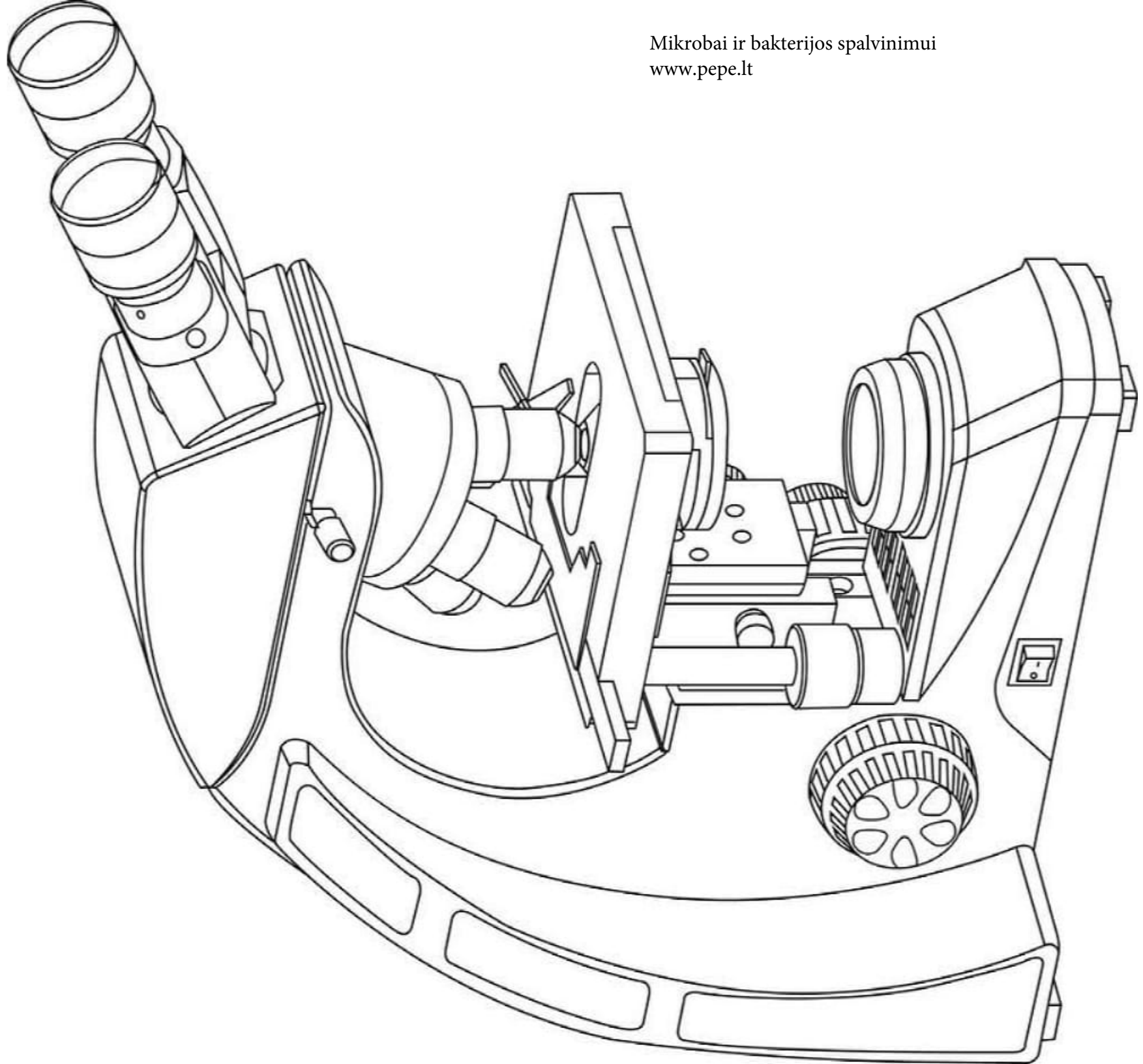

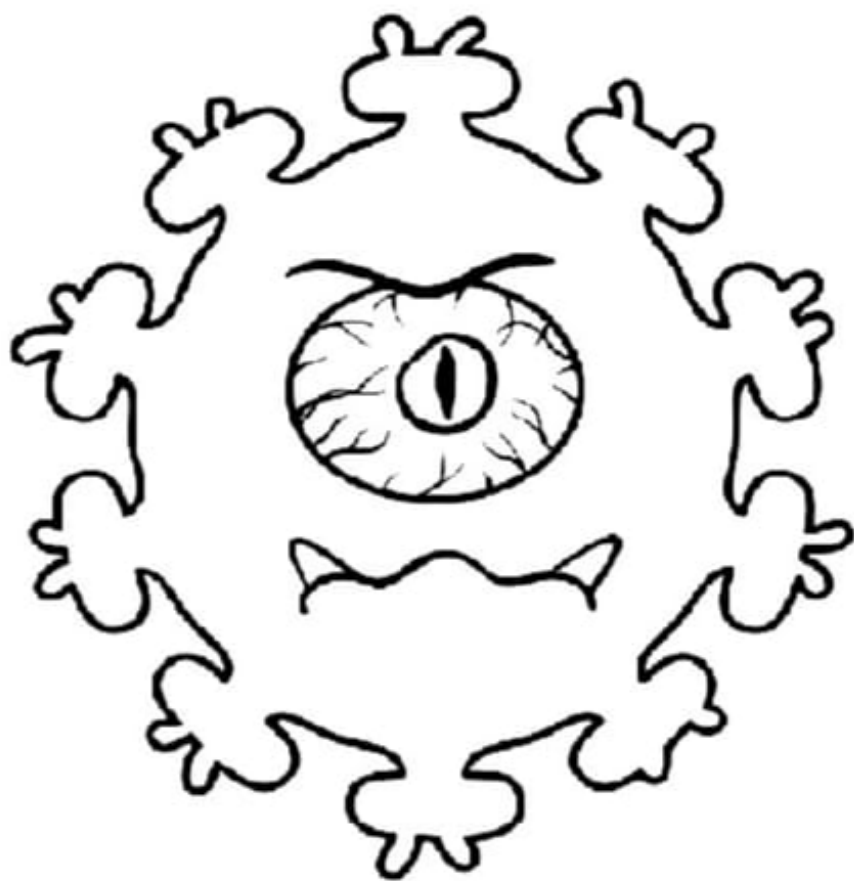
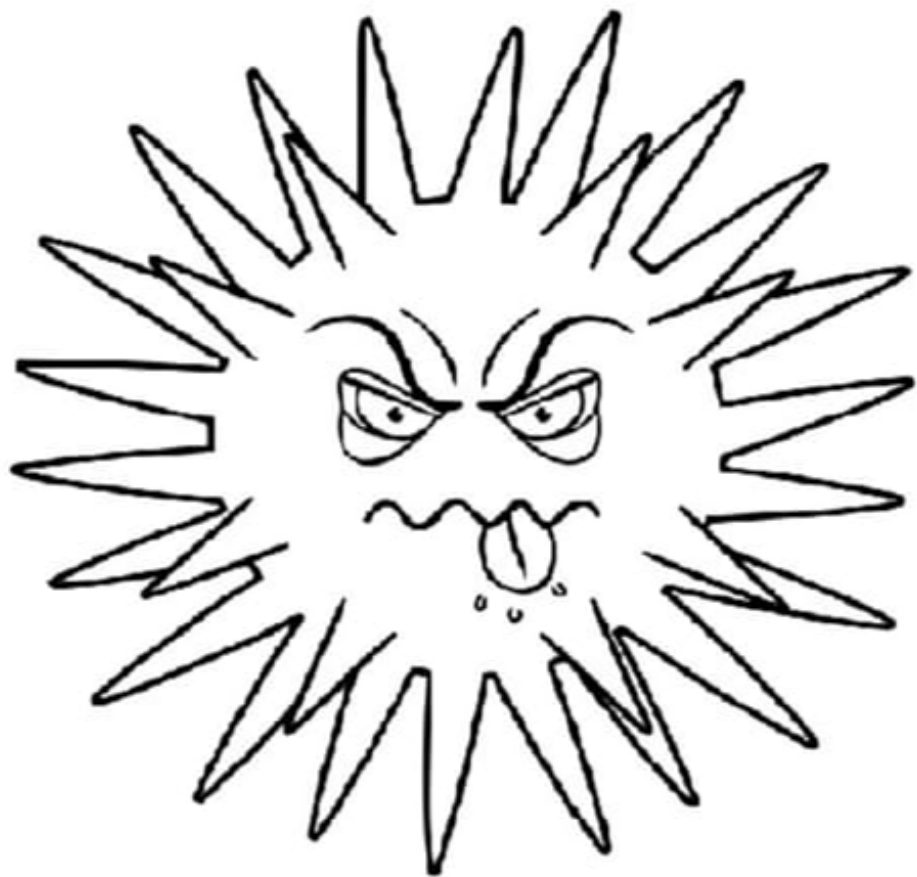

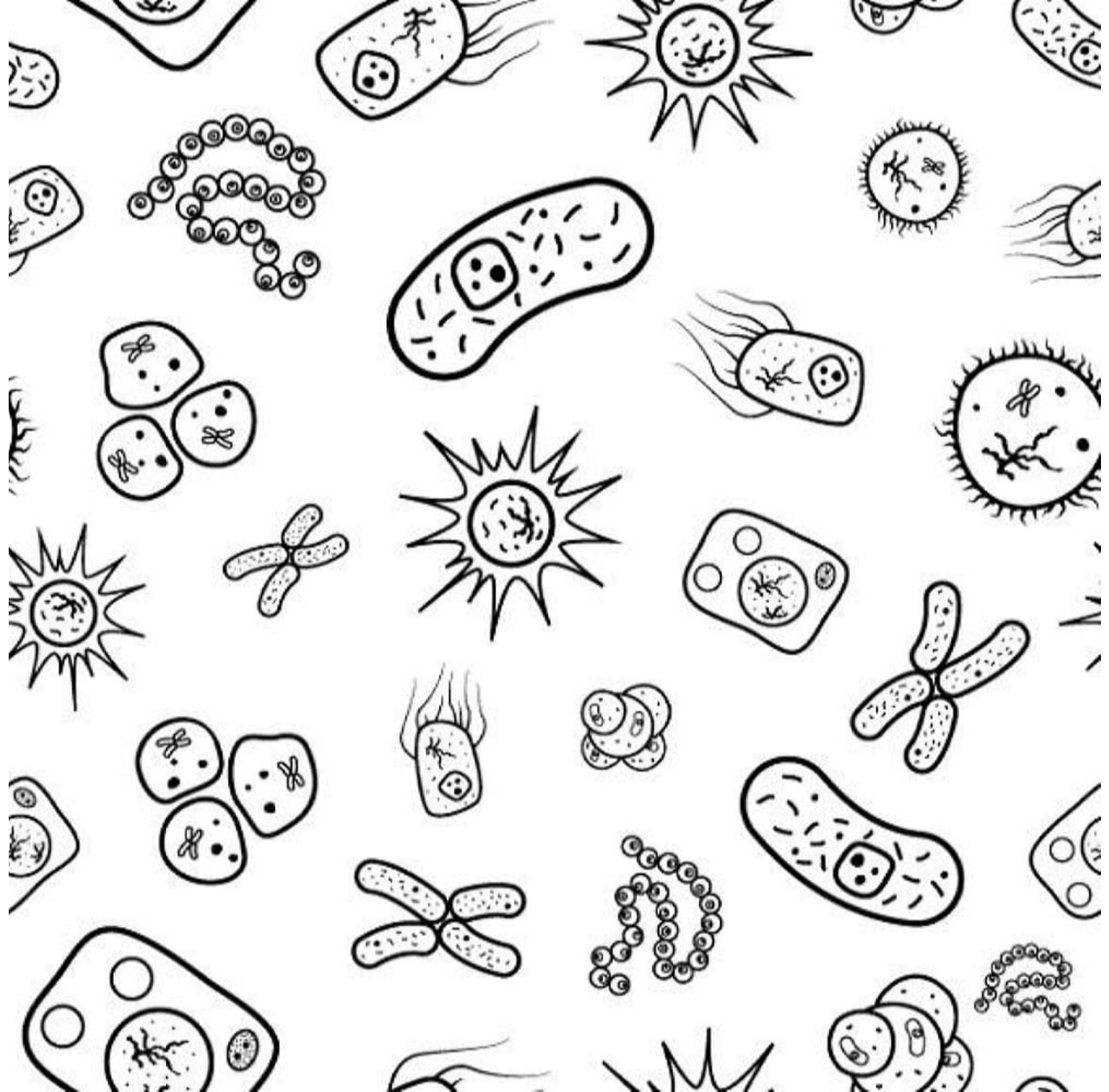

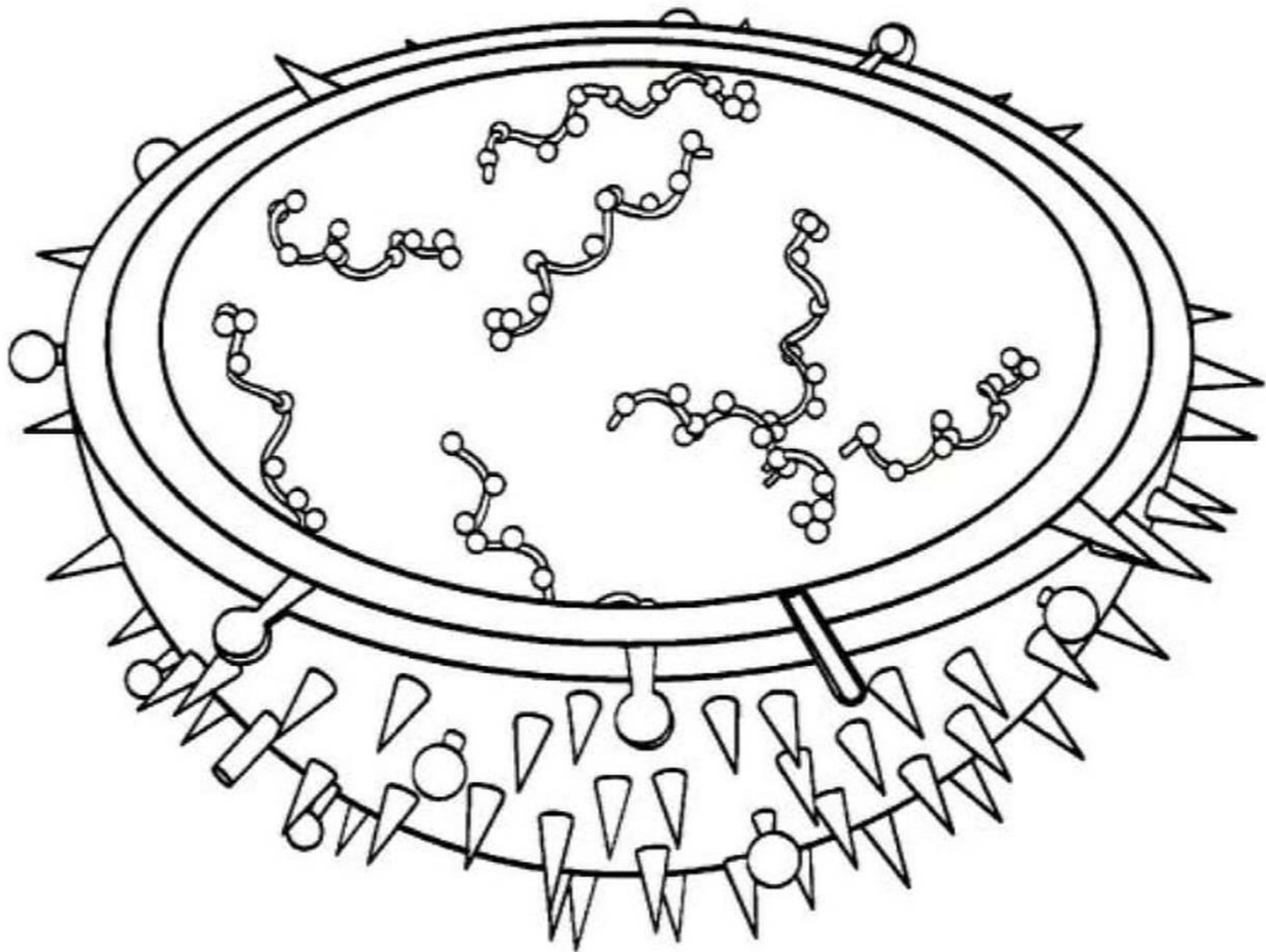

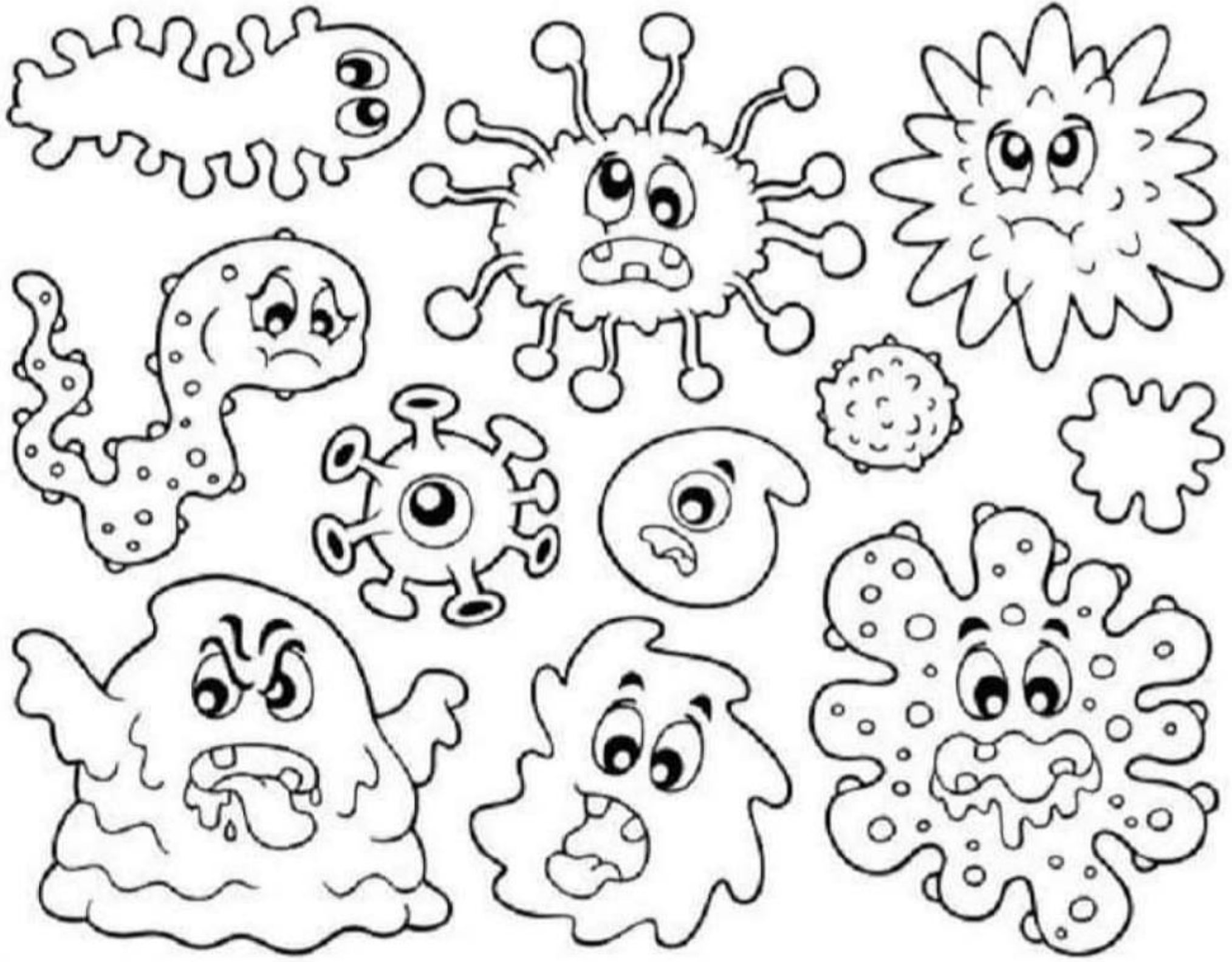

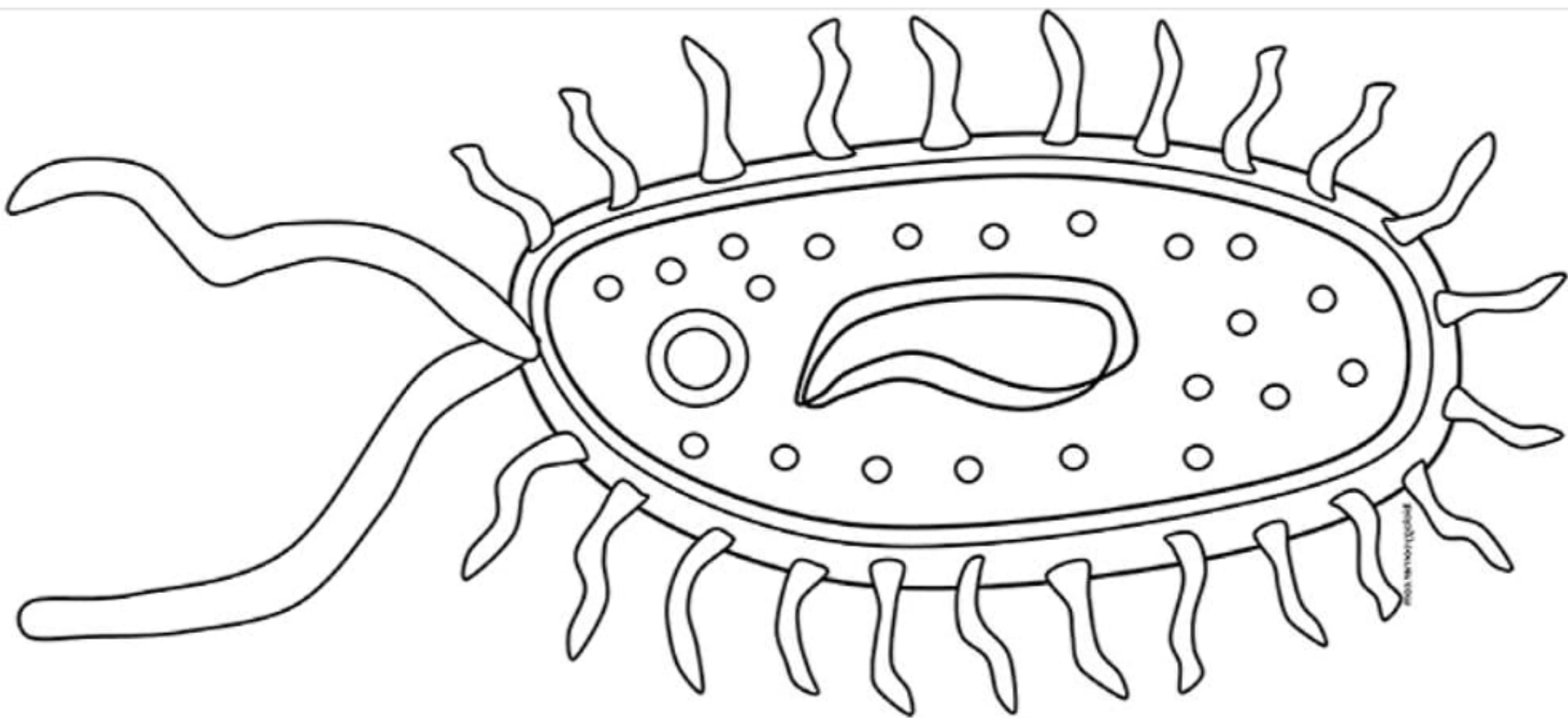

Bakterijos

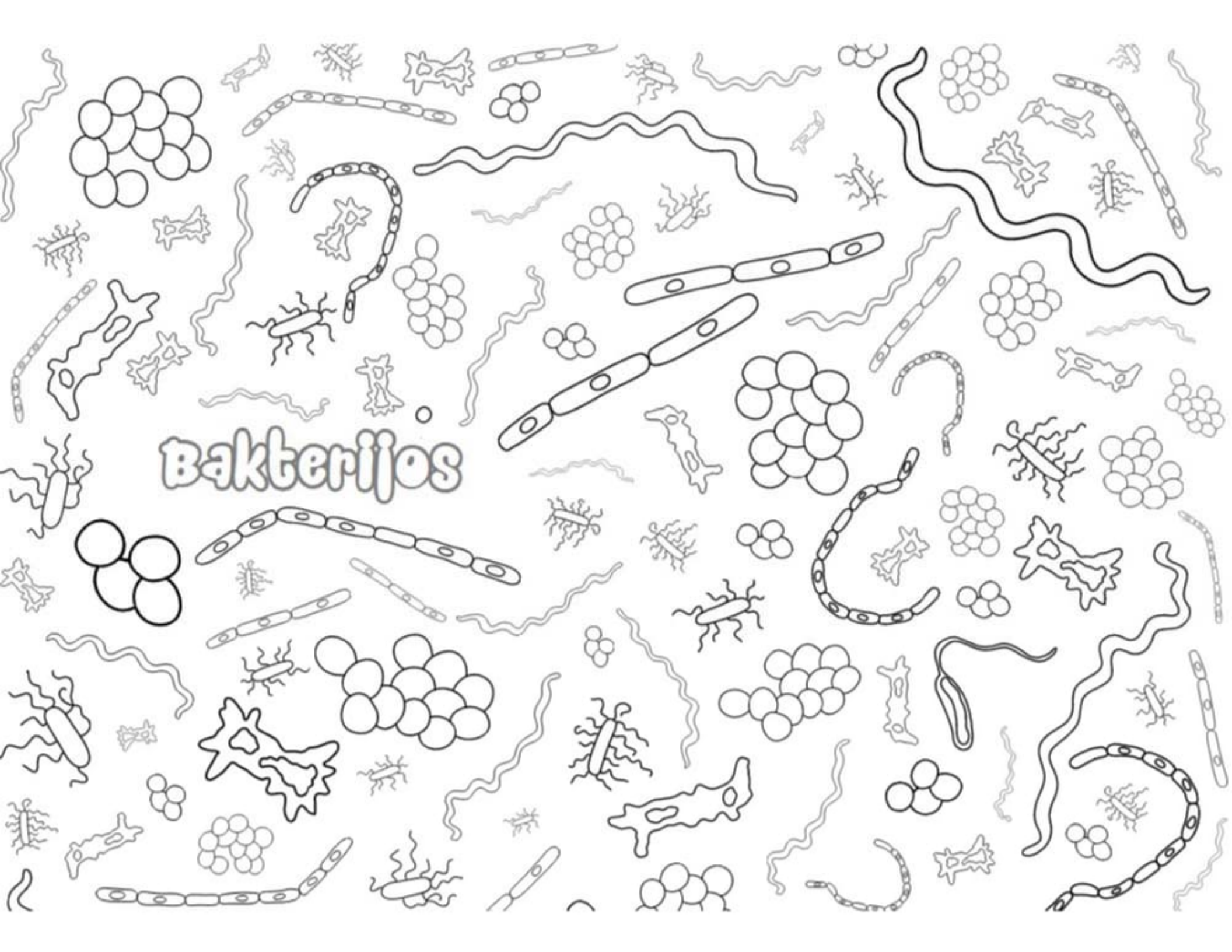

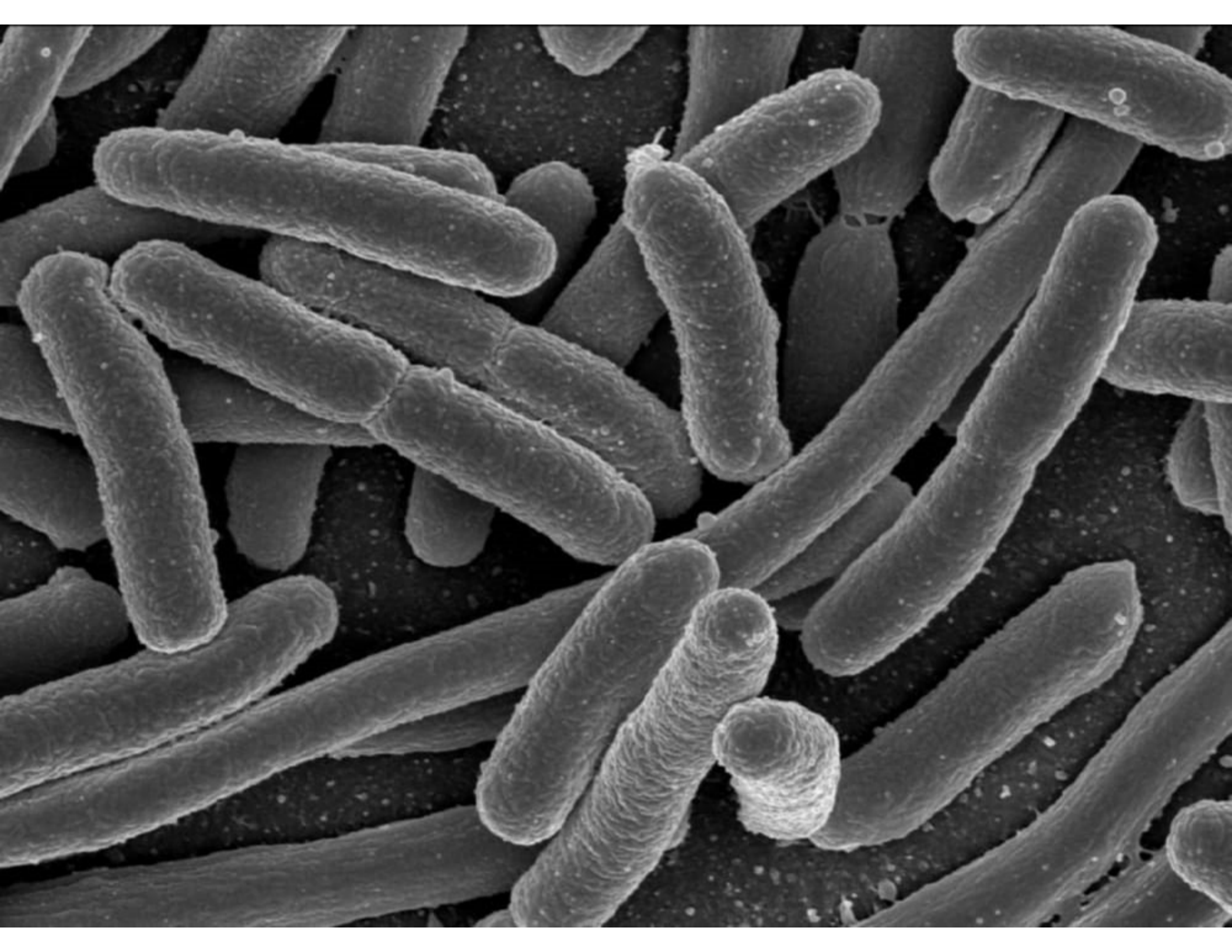

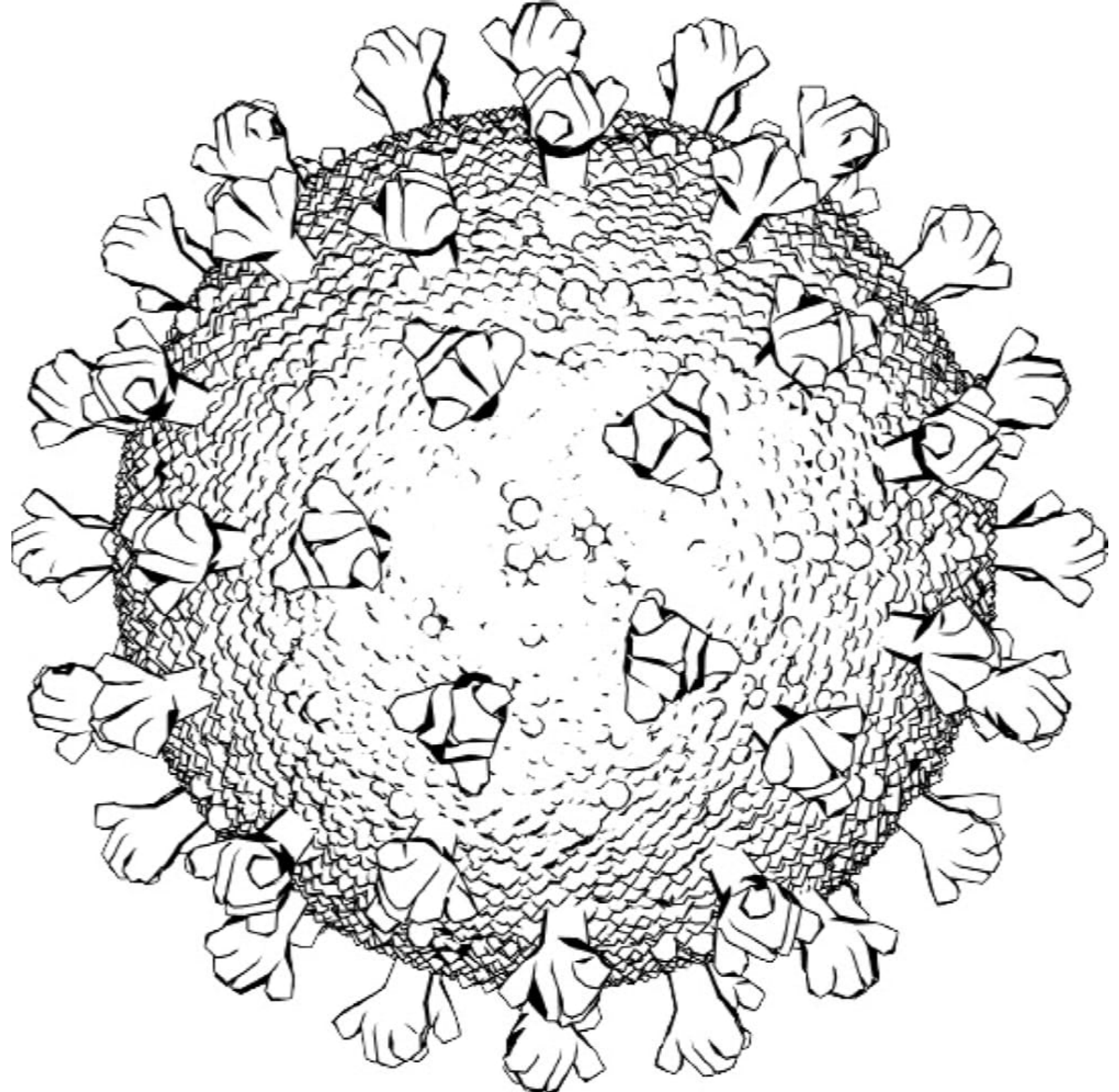

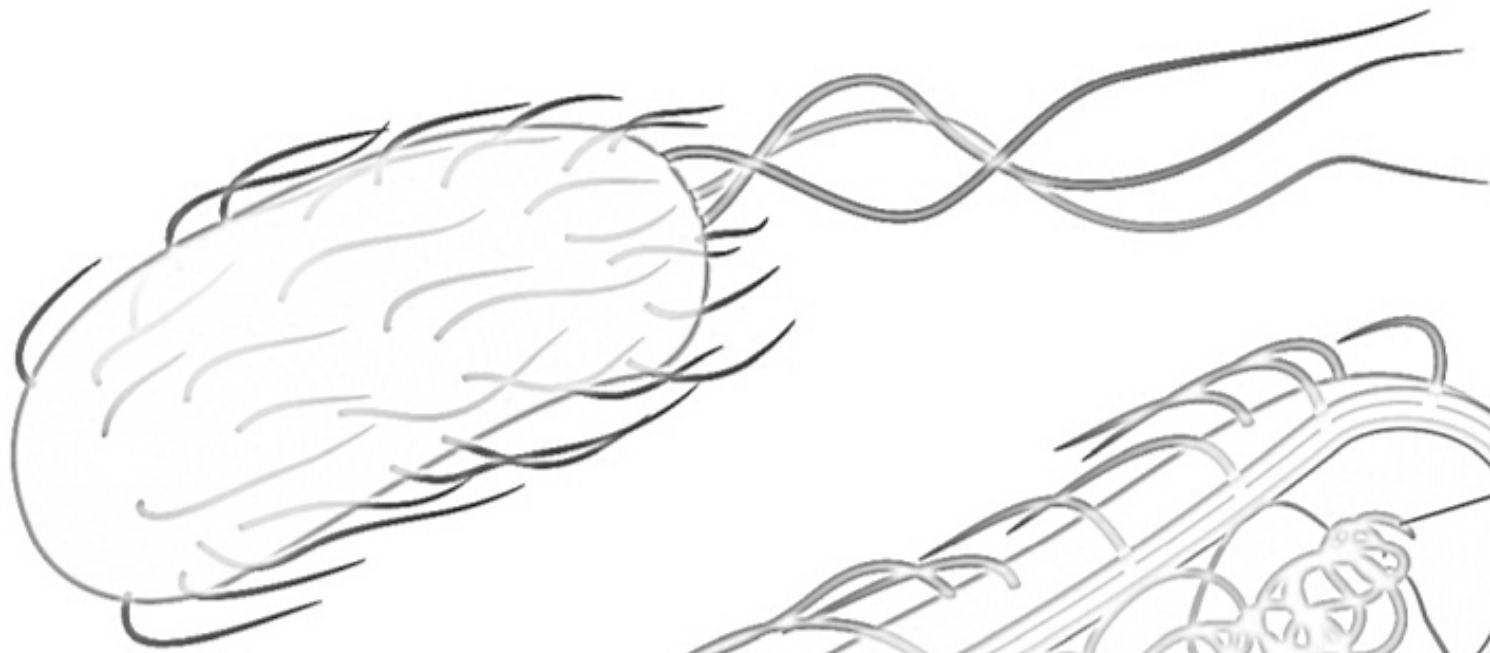

uodega

DNR

Useliai

